

WG101

1" Plane Wave Guide

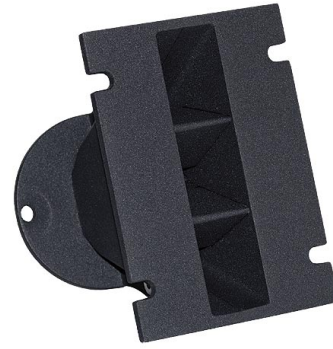

SPECIFICHE NOMINALI

Tipo	Guía de onda plana
Diámetro de la garganta	25.4 mm (1 in)
Rango de frecuencia	1÷20 kHz
Frecuencia de Cruce recomendada	1.6 kHz
Cobertura horizontal nominal (-6dB)	140°
Material	Al
Altura de la boca	122.3 mm (4.81 in)
Ancho de la boca	86 mm (3.39 in)
Profundidad	110 mm (4.33 in)
Agujeros de montaje de la boca (4x)	6.5 mm (0.26 in)
Peso neto	480 g (1.06 lb)
Caja de envío (Caja individual de cartón)	150 x 123 x 102 mm (5.9 x 4.8 x 4.0 in)
Peso envío	500 g (1.10 in)
Volumen neto del aire ocupado por la bocina	0.35 dm ³ (0.012 ft ³)

CODICE PRODOTTO (PART NUMBER)

Referencia pieza – Part Number (P/N)

TR992541

NOTE:

Se vende solo en combinación con el FaitalPRO 1" HF Driver

(1) 4 π sr carga acústica

(2) Valor promedio en el rango de frecuencias: 2÷16 kHz

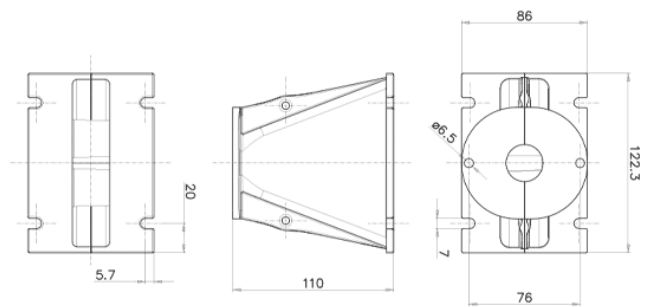

INDICE DI DIRETTIVITA'

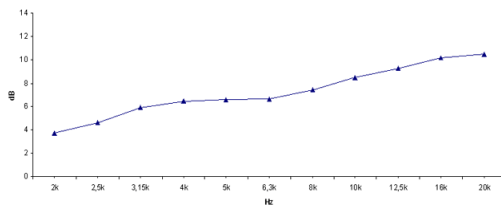

BEAMWIDTH

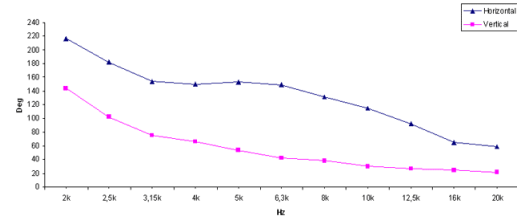

BEAMWIDTH ORIZZONTALE

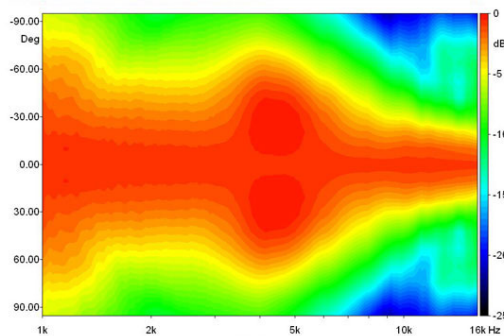

BEAMWIDTH VERTICALE



DIAGRAMMA POLARE ORIZZONTALE



DIAGRAMMA POLARE VERTICALE

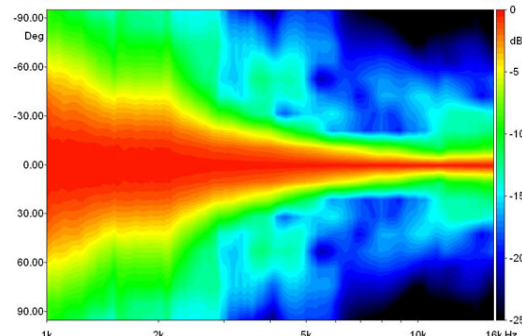
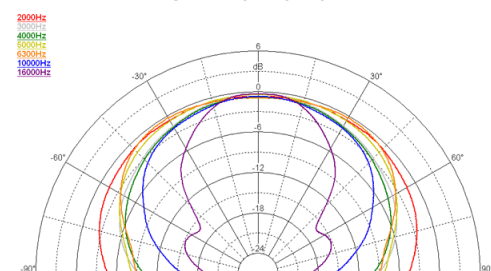